

# ENCPAD ASSEMBLY PARTS

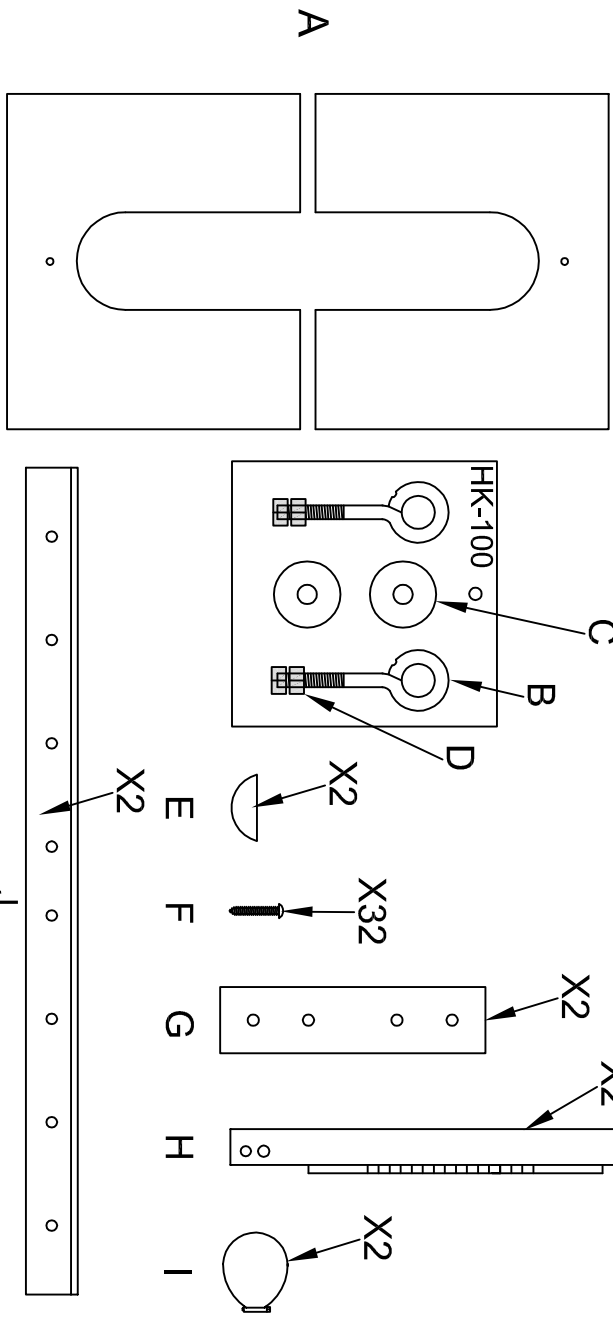

GUARDSHACK AND LOCKS SOLD SEPARATELY

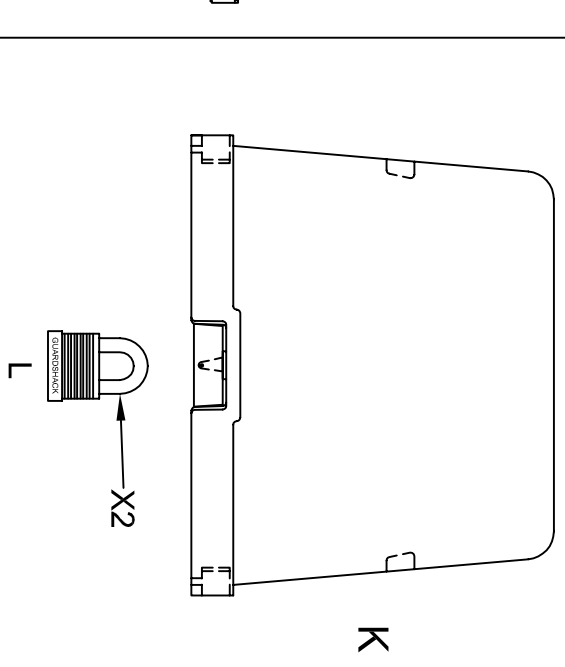

## STEP 1

### LEVEL GROUND

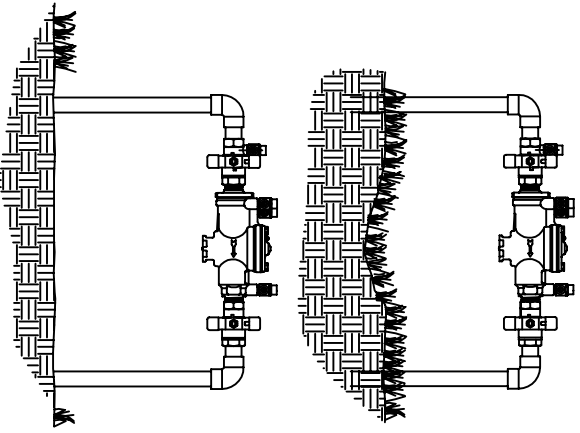

## STEP 2

### ATTACH EYE-BOLT

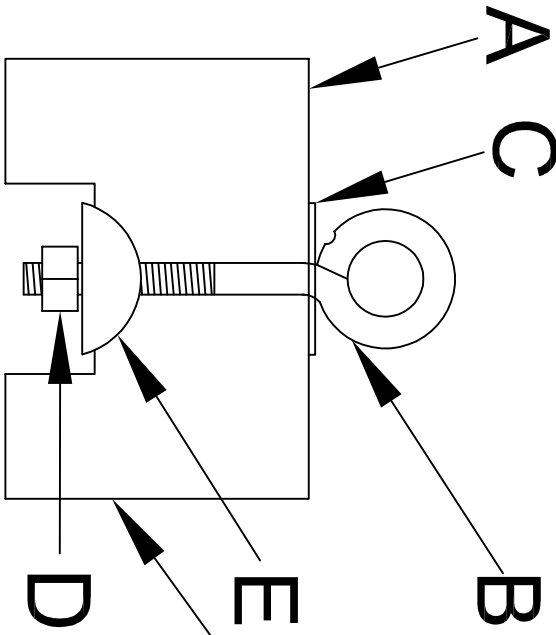

## STEP 3

### POSITION PAD

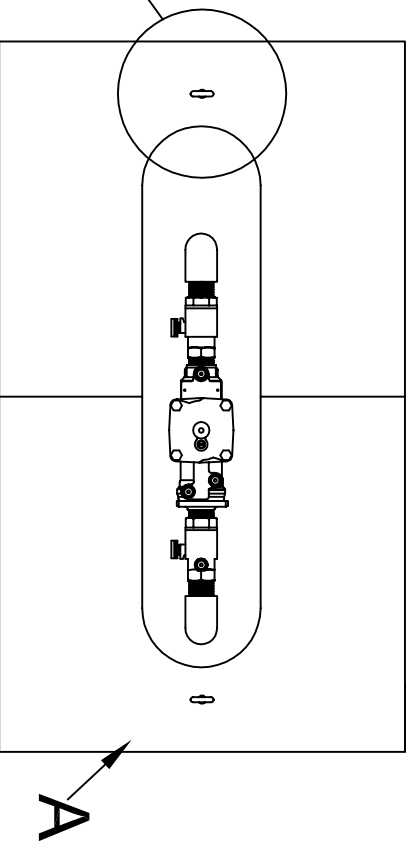

WWW.GUARDSHACKENCLOSURES.COM  
 (602) 426-1002 (800) 266-5411

**STEP 4**  
**INSTALL BRACKETS & BRACES**

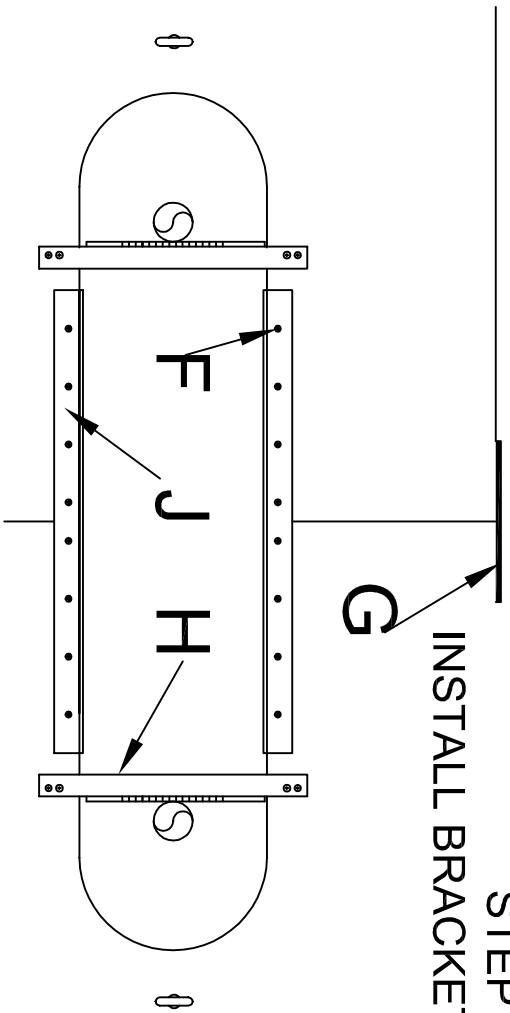

**STEP 5**  
**INSTALL CLAMP**

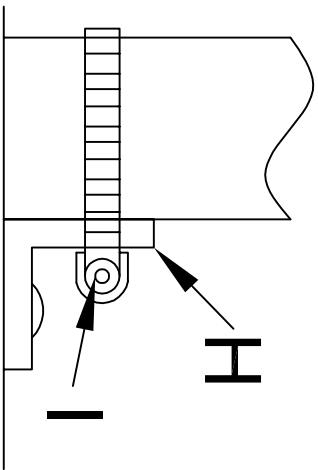

**STEP 6**  
**INSTALL ENCLOSURE**

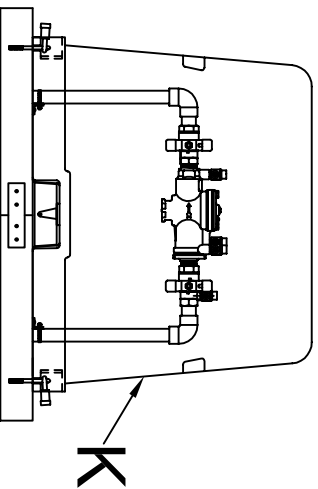

**DON'T FORGET THE LOCKS**

